



UNITED STATES PATENT AND TRADEMARK OFFICE

UNITED STATES DEPARTMENT OF COMMERCE
United States Patent and Trademark Office
Address: COMMISSIONER FOR PATENTS
P.O. Box 1450
Alexandria, Virginia 22313-1450
www.uspto.gov

INTERNATIONAL REGISTRATION NO.	APPLICATION NO.	FILING DATE	FIRST NAMED INVENTOR	ATTORNEY DOCKET NO.	CONFIRMATION NO.
DM/219153	35/513,766		SAMY RIO		4276

World Intellectual Property Organization
34, chemin des Colombettes, P.O. Box 18
1211 Geneva 20, Switzerland

DATE MAILED : 01/18/2023

NOTIFICATION OF REFUSAL

(Rule 18 of the Common Regulations under the Hague Agreement/ 37 CFR 1.1063)

Applicant must file any reply to this communication directly with the United States Patent and Trademark Office. Applicant may **NOT** file such reply through the International Bureau.

This refusal relates to all the industrial designs that are the subject of the international registration

DETAILED ACTION

Notice of AIA Status

The present application, filed on or after March 16, 2013, is being examined under the first inventor to file provisions of the AIA.

RESTRICTION NOT REQUIRED – CHANGE IN APPEARANCE

This application discloses the following embodiments:

Embodiment 1 – Figures 1.1-1.6 directed a portable light with feet-like features on the bottom, and a repeated pattern of circular features in the light source; and

Embodiment 2 – Figs 2.1-2.6 directed to portable light without feet-like features, and a plain light source.

Multiple embodiments of a single inventive concept may be included in the same design application only if they are patentably indistinct. See *In re Rubinfeld*, 270 F.2d 391, 123 USPQ 210 (CCPA 1959).

Embodiments that are patentably distinct from one another do not constitute a single inventive concept and thus may not be included in the same design application. See *In re Platner*, 155 USPQ 222 (Comm'r Pat. 1967).

The above identified embodiments are considered by the examiner to present overall appearances that are basically the same. Furthermore, the differences between the appearances of the embodiments are considered minor and patentably indistinct, or are shown to be obvious in view of analogous prior art cited. Accordingly, they are deemed to be obvious variations and are being retained and examined in the same application.

OBJECTION – SPECIFICATION

The specification is objected to for the following reasons:

The figure descriptions do not clearly and accurately represent the reproductions. The descriptions of the figures are not required to be written in any particular format, however, they must describe the views of the reproductions clearly and accurately. See Hague Rule 7(5)(a), 37 C.F.R. 1.1024, MPEOP 2920.04(a)11. For this reason, the figure descriptions must be amended to include more accurate descriptions for all figures. The following language and format are suggested:

- - **Fig. 1.1 is a top and side perspective view of the Portable Lamp showing my new design, according to a first embodiment;**
Fig. 1.2 is a side elevation view thereof;
Fig. 1.3 is a top plan view thereof;
Fig. 1.4 is a side perspective view;
Fig. 1.5; is another side perspective view showing the lamp in an illuminated state, thereof;
Fig. 1.6 is another side perspective view showing the lamp in an extended state;
Fig. 2.1 is a top and side perspective view of the Portable Lamp, according to a second embodiment;
Fig. 2.2 is a side elevation view thereof;
Fig. 2.3 is a top plan view thereof;
Fig. 2.4 is a side perspective view;
Fig. 2.5 is another side perspective view showing the lamp in an illuminated state, thereof; and
Fig. 2.6 is another side perspective view showing the lamp in an extended state. - -

Additionally, the description that reads [Reproductions 1.5 and 2.5 show the lamp lit] should be removed.

CLAIM REFUSAL – 35 U.S.C. § 112(A) AND (B)

The claim is rejected under 35 U.S.C. 112(a) and (b), as the claimed invention is not described in such full, clear, concise and exact terms as to enable any person skilled in the art to make and use the same, and fails to particularly point out and distinctly claim the subject matter which applicant regards as the invention.

The claim is indefinite and non-enabling for the following reasons:

- The claim is indefinite and non-enabling because the exact three-dimensional appearance of a port-like feature (exemplified in the bottom portion of Figure 1.2) cannot be understood without resorting to conjecture, due to the appearance of the element as very dark and lacking contrast. The extremely dark hue makes it impossible to distinguish the differences between the orientation and curvatures of planes, which may create a variety of different depths within the design. Without lighter images, the exact three-dimensionality of the areas cannot be understood. See the following annotation for reference:

Fig. 1.2

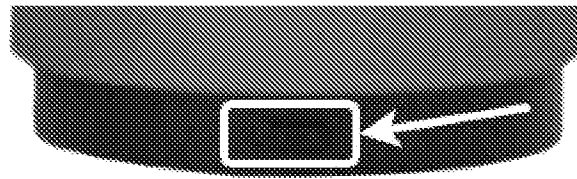

- Additionally, the exact three-dimensional appearance of the feet-like features in Figures 1.4 and 1.5 cannot be understood in the absence of alternative views. Specifically, it is impossible to distinguish the exact shape, depth, and spatial relationship of those elements. See the following annotation for reference:

Fig. 1.4



Applicant may indicate that protection is not sought for those portions of the reproductions which are considered indefinite and nonenabling in the rejection under 35 U.S.C. 112 above by amending the reproductions to color those portions or convert those portions to broken lines and by amending the specification to include a statement that the portions of the scooter shown in broken lines form no part of the claimed design or a statement that the portions of the scooter shown by coloring form no part of the claimed design provided such amendments do not introduce new matter (see 35 U.S.C. 132 , 37 CFR 1.121).

REPLACEMENT REPRODUCTIONS

Any amended replacement reproduction sheet should include all of the figures appearing on the immediate prior version of the sheet, even if only one figure is being amended. The figure or figure number of an amended reproduction should not be labeled as “amended.” If a reproduction figure is to be canceled, the appropriate figure must be removed from the replacement sheet, and where necessary, the remaining figures must be renumbered and appropriate changes made to the brief description of the several views of the reproductions for consistency. Additional replacement sheets may be necessary to

show the renumbering of the remaining figures. Each reproduction sheet submitted after the filing date of an application must be labeled in the top margin as either "Replacement Sheet" or "New Sheet" pursuant to 37 CFR 1.121(d). If the examiner does not accept the changes, the applicant will be notified and informed of any required corrective action in the next office action. The corrected reproductions must not contain new matter (35 U.S.C. 132; 37 CFR 1.121).

CONCLUSION

In summary, the claim stands rejected under 35 U.S.C. 112(a) and (b) as set forth above.

Applicant is reminded that any reply to this Refusal must be signed either by a patent practitioner (i.e., a patent attorney or agent registered to practice before the United States Patent and Trademark Office) or by the applicant. If the applicant is a juristic entity, the reply must be signed by a patent practitioner. See 37 CFR 1.33(b).

The USPTO transacts business in writing. Applicants may submit replies to Office actions only by:

- Online via the USPTO's Electronic Filing System-Web (EFS-Web) (Registered eFilers only)

<https://www.uspto.gov/patents-application-process/applying-online/efs-web-guidance-and-resources>

- Mail: Commissioner For Patents, P.O. Box 1450, Alexandria, VA, 22313-1450
- Mailing should be done sufficiently in advance to ensure the USPTO receipt prior to reply period expiration
- Facsimile to the USPTO's Official Fax Number (571-273-8300) (Do Not Fax Formal Reproductions)
- Hand-carry to USPTO's Alexandria, Virginia Customer Service Window

For additional information regarding responding to office actions see:

<https://www.uspto.gov/patents-maintaining-patent/responding-office-actions>

Note that correspondence received will appear in Patent Center, which may be viewed by the applicant at: <https://patentcenter.uspto.gov>.

The references are cited as pertinent prior art. Applicant may view and obtain copies of the cited references by visiting <http://www.uspto.gov/patft/index.html> and pressing the "Patent Number Search" button.

CONTACT INFORMATION

Any inquiry concerning this communication or earlier communications from the examiner should be directed to SARAH LYNNE SMITH whose telephone number is 571-272-6076.

If attempts to reach the examiner by telephone are unsuccessful, the examiner's supervisor, Eric L Goodman, can be reached at telephone number 571-272-4734. The fax phone number for the organization where this application or proceeding is assigned is 571-273-8300.

Information regarding the status of an application may be obtained from the Patent Center. Unpublished application information in Patent Center is available to registered users. To file and manage patent submissions in Patent Center, please visit: <https://patentcenter.uspto.gov>. Visit <https://uspto.gov/patents/apply/patent-center> for more information about Patent Center, and <https://uspto.gov/patents/docx> for information about filing in DOCX format. For additional questions, contact the Electronic Business Center (EBC) at 866-217-9197 (toll free). If you would like assistance from a USPTO Customer Service representative, call 800-786-9199 (in USA or Canada), or 571-272-1000.

Examiner interviews are available via telephone, in-person, and video conferencing using a USPTO supplied web-based collaboration tool. To schedule an interview, applicant is encouraged to use the USPTO Automated Interview Request (AIR) at <http://www.uspto.gov/interviewpractice>.

/SLS/

Examiner, Art Unit 2919

/CHRISTY NEMETH/

Primary Examiner, Art Unit 2922

Notice of References Cited

Application/Control No. 35/513,766	Applicant(s)/Patent Under Reexamination RIO, SAMY	
Examiner SARAH L SMITH	Art Unit 2919	Page 1 of 2

U.S. PATENT DOCUMENTS

*		Document Number Country Code-Number-Kind Code	Date MM-YYYY	Name	CPC Classification	US Classification
*	A	US-D318817-S	08-1991	Sinrod; Harold S.		D10/114.9
*	B	US-20090059572-A1	03-2009	WANG; Ching-Hsiang	F21S9/037	362/183
*	C	US-D596773-S	07-2009	Liu; Yun-Zhao		D26/37
*	D	US-D599933-S	09-2009	van Klinken; Dido		D26/67
*	E	US-D672075-S	12-2012	Abogabir; Ximena Munoz		D26/68
*	F	US-D739065-S	09-2015	Macura; Marko		D26/67
*	G	US-D739067-S	09-2015	Macura; Marko		D26/67
*	H	US-D752265-S	03-2016	Schneider; Torsten B.		D26/51
*	I	US-D809173-S	01-2018	Schneider; Torsten Bernd		D26/51
*	J	US-D827899-S	09-2018	Li; Xiaofeng		D10/114.2
*	K	US-D845527-S	04-2019	Hsu; Kevin		D26/41
*	L	US-D894468-S	08-2020	Hollopeter; Michael		D26/113
*	M	US-D942409-S	02-2022	Hsu; Kevin		D14/204

FOREIGN PATENT DOCUMENTS

*		Document Number Country Code-Number-Kind Code	Date MM-YYYY	Country	Name	CPC Classification
*	N	KR-20100019123-A	02-2010	KR	Kang Kyung Jong	
*	O	CN-105546411-A	05-2016	CN	MAO H	B43K29/004
*	P	KR-2018067999-A	06-2018	KR	PARK N H	B43K29/004
	Q	008498281-0002	04-2021	EU	Suzhou Linyi Electronic Technology Co Ltd	26-05
*	R	CN-214663822-U	11-2021	CN	SHI F	
	S	307021590	12-2021	CN	Shenzhen Leite Network Technology Co Ltd	26-02
	T	307043647	12-2021	CN	Zhongshan Xianglin Lighting Technology Co Ltd	26-05

NON-PATENT DOCUMENTS

*		Include as applicable: Author, Title Date, Publisher, Edition or Volume, Pertinent Pages)
	U	"Nuvo 62/1303 Blink Slim Pendant," 11 October 2018, amazon.com, site visited 11 January 2023, URL: https://www.amazon.com/Nuvo-Lighting-62-1303-Blink/dp/B07JBWK4TH?source=ps-sl-shoppingads-lpcontext&ref_=fplfs&smid=ATVPDKIKX0DER&th=1 (Year: 2018)
	V	"JALVDE Cordless Rechargeable LED Table Lamp," 16 October 2020, amazon.com, site visited 11 January 2023, URL: https://www.amazon.com/Cordless-Rechargeable-Brightness-Restaurant-Dormitory/dp/B08LMQ3G2B?th=1 (Year: 2020)
	W	Hall17, "I love this table!" January 2021 (review), crateandbarrel.com, site visited 11 January 2023, URL: https://www.crateandbarrel.com/willy-white-plaster-pedestal-side-table/s400832 (Year: 2021)
	X	

*A copy of this reference is not being furnished with this Office action. (See MPEP § 707.05(a).)
Dates in MM-YYYY format are publication dates. Classifications may be US or foreign.

Notice of References Cited

Application/Control No.
35/513,766

Applicant(s)/Patent Under
Reexamination
RIO, SAMY

Examiner
SARAH L SMITH

Art Unit
2919

Page 2 of 2

U.S. PATENT DOCUMENTS

*		Document Number Country Code-Number-Kind Code	Date MM-YYYY	Name	CPC Classification	US Classification
*	A	US-D971050-S	11-2022	Redfern; Steve Antony		D10/114.1
	B					
	C					
	D					
	E					
	F					
	G					
	H					
	I					
	J					
	K					
	L					
	M					

FOREIGN PATENT DOCUMENTS

*		Document Number Country Code-Number-Kind Code	Date MM-YYYY	Country	Name	CPC Classification
	N					
	O					
	P					
	Q					
	R					
	S					
	T					

NON-PATENT DOCUMENTS

*		Include as applicable: Author, Title Date, Publisher, Edition or Volume, Pertinent Pages)
	U	
	V	
	W	
	X	

*A copy of this reference is not being furnished with this Office action. (See MPEP § 707.05(a).)
Dates in MM-YYYY format are publication dates. Classifications may be US or foreign.

1/1-DESIGNS-©Questel

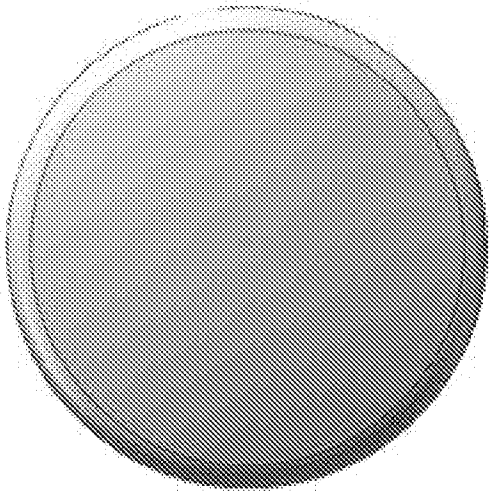
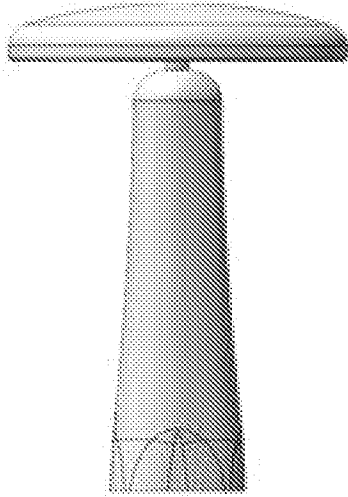

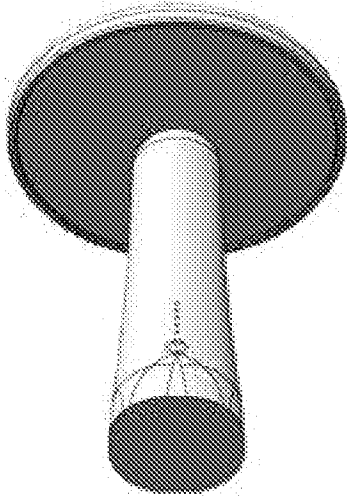
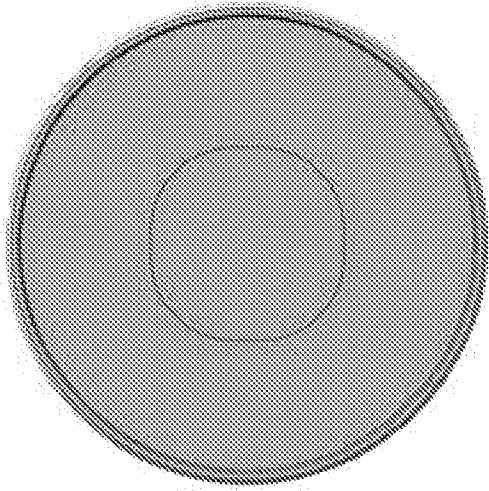

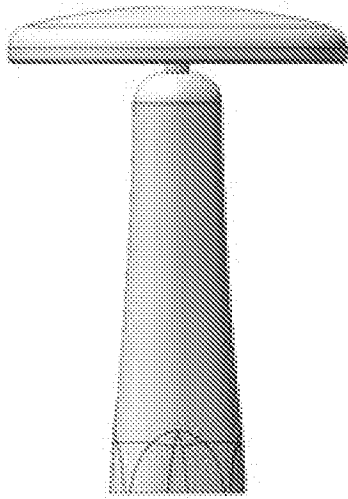
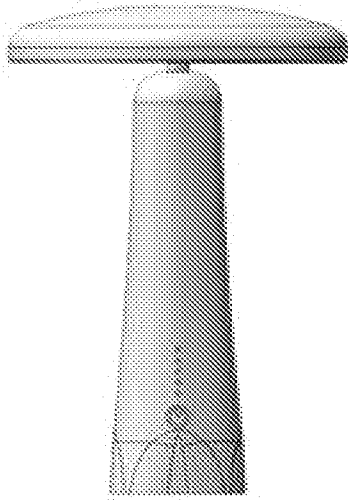

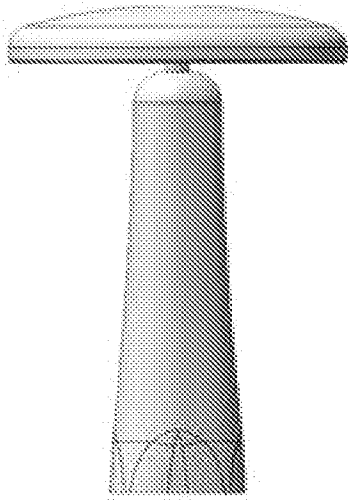
**Title**

Light modulation toning **portable** desk lamp (TL01004)

Country code

CN

Serial number of registration

307043647

Date of the registration

2021-12-31

Expiration date of renewal

2036-08-31

Application number

202130571618.4

App. date

2021-08-31

Publication date

2021-12-31

Locarno class

26-05

Designation in English

Light modulation toning **portable** desk lamp (TL01004)

Original title

调光调色便携式台灯 (TL01004)

Description

1. the title of present design product: light modulation toning portable desk lamp (TL01004).
2. the purposes of present design product: for illuminating.
3. the designing points of present design product: it is shape.
4. it most can be shown that the picture or photo of designing points: stereogram.

Original description

- 1.本外观设计产品的名称：调光调色便携式台灯（TL01004）。
- 2.本外观设计产品的用途：用于照明。
- 3.本外观设计产品的设计要点：在于形状。

4.最能表明设计要点的图片或照片：立体图。

Fig. 1: 主视图

Fig. 2: 后视图

Fig. 3: 左视图

Fig. 4: 右视图

Fig. 5: 俯视图

Fig. 6: 仰视图

Fig. 7: 立体图

Creator

Chen Jianping

Creator (Original)

陈健平

Creator address

Chen Jianping

Name and address of owner

ZHONGSHAN XIANGLIN LIGHTING TECHNOLOGY CO LTD, second floor, first floor, third floor and fourth floor, building 2, No. 38, Xinmao Industrial Avenue, Henglan Town, Zhongshan City, Guangdong Province, 528400 zhongshan, Municipal District, (CN)

Name and address of owner (Original)

中山市祥霖照明科技有限公司, 广东省横栏镇新茂工业大道38号第二幢一楼之二、三楼之一、四楼, 528400 中山市, 市辖区

Owner name

ZHONGSHAN XIANGLIN LIGHTING TECHNOLOGY CO LTD

Owner address

second floor, first floor, third floor and fourth floor, building 2, No. 38, Xinmao Industrial Avenue, Henglan Town, Zhongshan City, Guangdong Province, 528400 zhongshan, Municipal District

Agent name and address

Zhongshan Mingyang Patent & Trademark Office (general partnership)

Agent name and address (Original)

中山市铭洋专利商标事务所(普通合伙)

Agent country

中山市铭洋专利商标事务所(普通合伙)

Legal status

2021-12-31 - Granted

1/1-DESIGNS-©Questel

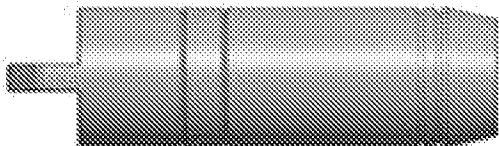
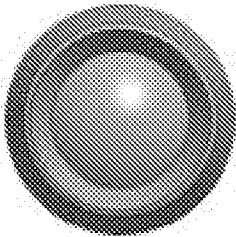
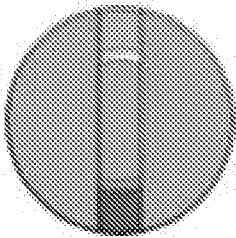
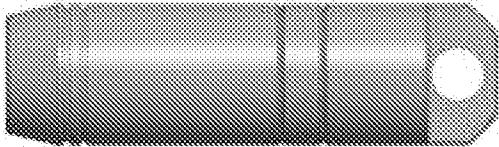
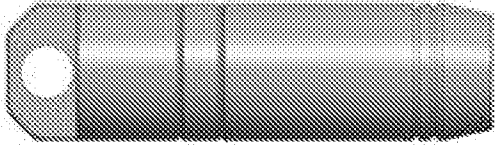

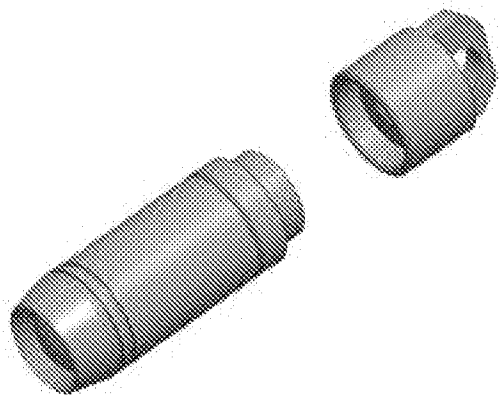
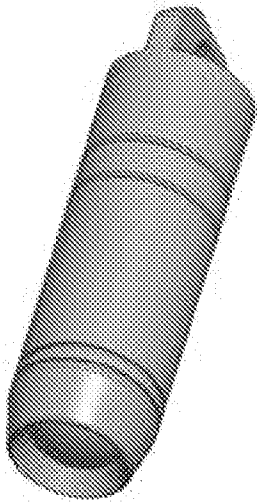
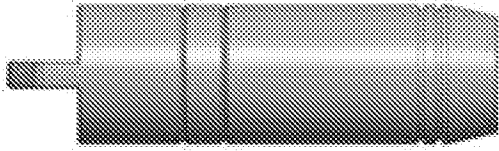

Title
Magnetic flashlight
Country code
CN
Serial number of registration
307021590
Date of the registration
2021-12-21
Expiration date of renewal

2036-08-12

Application number
202130521362.6

App. date
2021-08-12

Publication date
2021-12-21

Locarno class
26-02

Designation in English
Magnetic flashlight

Original title
磁吸手电筒

Description

1. the title of present design product: magnetic flashlight.
2. the purposes of present design product: it for illuminating, using the magnetic of magnet, can arbitrarily be fixed on any ironware, discharge both hands.
3. the designing points of present design product: it is shape.
4. it most can be shown that the picture or photo of designing points: stereogram.

Original description

- 1.本外观设计产品的名称：磁吸手电筒。
- 2.本外观设计产品的用途：用于照明，利用磁铁的磁吸，可随意固定在任何铁件上，释放双手。
- 3.本外观设计产品的设计要点：在于形状。
- 4.最能表明设计要点的图片或照片：立体图。

- Fig. 1: 主视图
Fig. 2: 后视图
Fig. 3: 左视图
Fig. 4: 右视图
Fig. 5: 俯视图
Fig. 6: 仰视图
Fig. 7: 立体图
Fig. 8: 使用状态图

Creator
Liu Jun

Creator (Original)
刘军

Creator address
Liu Jun

Name and address of owner
Shenzhen Leite Network Technology Co Ltd, 1602, 16 V F, building B, Datang times commercial complex, No. 2203, Meilong Avenue, Qinghua community, Longhua street, Longhua District, Shenzhen, Guangdong, 518100 Shenzhen City, Baoan District, (CN)

Name and address of owner (Original)
深圳雷特网络科技有限公司, 广东省龙华区龙华街道清华社区梅龙大道2203号大唐时代商业综合楼B栋16层1602, 518100 深圳市, 宝安区

Owner name
Shenzhen Leite Network Technology Co Ltd

Owner address
1602, 16 V F, building B, Datang times commercial complex, No. 2203, Meilong Avenue, Qinghua community, Longhua street, Longhua District, Shenzhen, Guangdong, 518100 Shenzhen City, Baoan District

Legal status
2021-12-21 - Granted

1/1-DESIGNS-©Questel

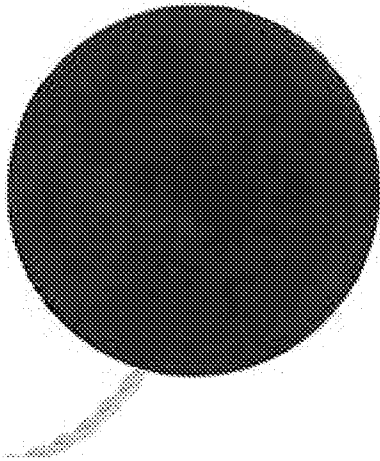
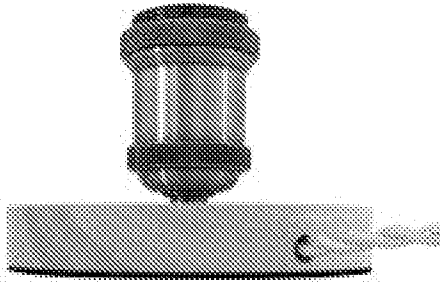

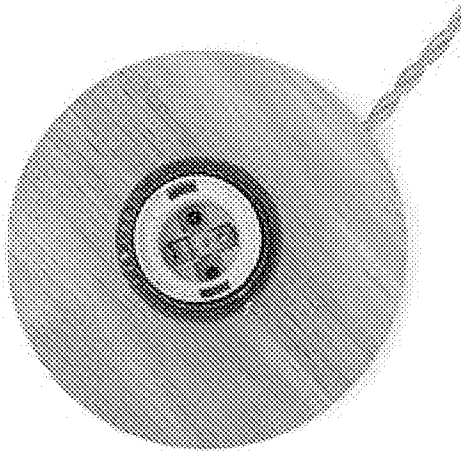
**Title**

Lamps [non portable]

Country code

EU

Serial number of registration

008498281-0002

Date of the registration

2021-04-12

Expiration date of renewal

2026-04-12

Application number

008498281-0002

App. date

2021-04-12

Language of filing

EN; FR

Publication date

2021-04-13

Locarno class

26-05

Designation in English

Lamps [non portable]

Designation in French

Lampes non portatives

Original title

Ortsfeste Leuchten

Lamput [ei kannettavat]

Lampor [ej bärbara]

Lâmpadas [não portáteis]

Лампи [непреносими]

Λαμπτήρες [μη φορητοί]

Lampi [ma jingarrux]

Lempos [stacionarios]

Lampas [nepāmēsājamās]

Svjetiljke /neprenosive/
Lampade [non portatili]
Lámpák [nem hordozható]
Lámparas [no portátiles]
Mitteteisaldatavad lambid
Lampy [nepřenosné]
Lampy [neprenosné]
Svetilke [neprenosne]
Lampy [nieprzenośne]
Lamper [ikke bærbare]
Lämpö [fixe]
Lampen [niet draagbaar]

Creator

Wei Fan

Creator address

Wei Fan

Name and address of owner

Suzhou Linyi Electronic Technology Co., Ltd., Room B712, Building 4, Tianhe West Garden, Yangshe Town, Zhangjiagang City, Suzhou, Jiangsu, (CN)

Owner name

Suzhou Linyi Electronic Technology Co., Ltd.

Owner address

Room B712, Building 4, Tianhe West Garden, Yangshe Town, Zhangjiagang City, Suzhou, Jiangsu

Agent name and address

MARIA IOANNIDES, 16B ANDREA KALVOU DHALI, CY-2546 NICOSIA, (CY)

Legal status

2021-04-13 - Registered and fully published (A1)

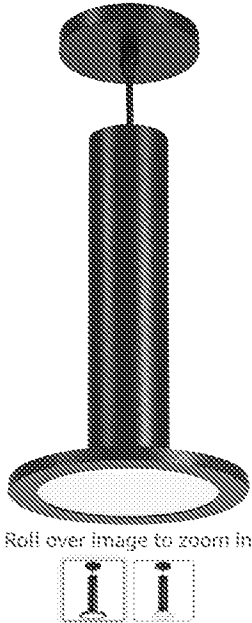

Roll over image to zoom in



Nuvo 62/1303 Blink Slim Pendant Conversion Kit, Bronze, 7-Inch Kit

Visit the Nuvo Store

\$52.59

FREE Returns

Get \$50 off instantly. Pay \$2.59 ~~\$52.59~~ upon approval for the Amazon Rewards Visa Card. No annual fee.

Color: **Bronze**



Size: **7-Inch Kit**

7-Inch Kit	9-Inch Kit
\$52.59	See available options

Brand	Nuvo
Color	Bronze
Material	Steel
Light fixture form	Pendant
Room Type	Bedroom, Living Room, Dining Room, Kitchen, Kids, Nursery, Bathroom, Office

About this item

- Blink Slim pendant conversion kits provide additional functionality to a versatile product
- For use with Blink Slim 7 inch round LED fixtures (sold separately)
- Comes with pendant, ceiling canopy, 12ft cord, and mounting hardware for a fast, customizable conversion
- 1-year limited warranty
- Finish options are white, bronze, brushed nickel, or polished nickel

> See more product details

Similar item to consider

Delivery

Pickup

\$52.59

FREE Returns

FREE delivery **Tuesday, January 17**

Or fastest delivery **Monday, January 16**. Order within 7 hrs 5 mins

Select delivery location

Available to ship in 1-2 days.

Qty: 1

Add to Cart

Buy Now

Secure transaction

Ships from Amazon.com
Sold by Amazon.com

Return policy: Eligible for Return, Refund or Replacement within 30 days of receipt.



Enjoy fast, FREE delivery, exclusive deals and award-winning movies & TV shows with Prime
Try Prime and start saving today with **Fast, FREE Delivery**

Add a Protection Plan:

- 3-Year Protection for \$6.99
- 4-Year Protection for \$9.99
- Add a gift receipt for easy returns

Add to List

New (7) from \$51.20 & FREE Shipping

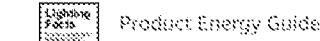

Product Information

Technical Details

Brand	Nuvo
Color	Bronze
Material	Steel
Light fixture form	Pendant
Room Type	Bedroom, Living Room, Dining Room, Kitchen, Kids, Nursery, Bathroom, Office
Usage	Ceiling light
Indoor/Outdoor Usage	Indoor
Power Source	AC
Installation Method	Built-In
Special Feature	1-year limited warranty, Conversion Kit, Steel
Light Source Type	LED
Finish Type	Finished
Shade Material	Metal
Voltage	120 Volts
Shape	Round
Included Components	Installation instructions and mounting hardware
Warranty Type	Manufacturer
Lighting Method	Downlight
Certification	ROHS
Item Weight	1 Pounds
Number of Items	1
Manufacturer	Nuvo Lighting
Part Number	62/1303
Item Weight	1 pounds
Product Dimensions	7 x 7 x 12.25 inches
Country of Origin	China
Item model number	62/1303
Size	7-Inch Kit
Finish	Finished
Item Package Quantity	1
Number Of Pieces	1
Measurement System	English/Standard
Mounting Type	Ceiling Mount
Plug Format	A- US style

Additional Information

ASIN	B07JBWK4TH
Best Sellers Rank	#1,711,082 in Tools & Home Improvement (See Top 100 in Tools & Home Improvement) #17,932 in Pendant Light Fixtures
Date First Available	October 11, 2018

Warranty & Support

If you'd like a copy of the manufacturer's warranty for a product found on Amazon.com, you can contact the manufacturer directly or visit their website for more information. Manufacturer's warranties may not apply in all cases, depending on factors like the use of the product, where the product was purchased, or who you purchased the product from. Please review the warranty carefully, and contact the manufacturer if you have any questions.

Feedback

Would you like to tell us about a lower price? --

amazon EN Hello, sign in **Account & Lists** **Returns & Orders**

Tools & Home Improvement

All Clinic Customer Service Best Sellers Amazon Basics Today's Deals Prime New Releases Books Music Gift Cards Registry

Tools & Home Improvement Best Sellers Deals & Savings Gift Ideas Power & Hand Tools Lighting & Ceiling Fans Kitchen & Bath Fixtures Smart Home

Hapfish Cordless LED Table Lamp, 5000mAh Rechargeable Battery Operated Desk Lamps, 3 Color Modes, Dimmable, Wireless Small Lights for Bedroom / Outdoor / ... ★★★★☆ 82 **\$39.99** prime 10% off coupon

Customers who viewed this item also viewed Sponsored

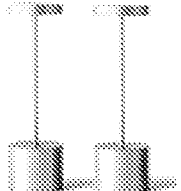

2 Pack Cordless Table Lamp
Rechargeable, 5000mAh Battery Powered Table
★★★★☆ 734
\$69.99



YHT Rechargeable Cordless LED Table Lamp, Portable USB Metal Desk Lamp 6000mAh Battery
★★★★☆ 223
\$89.99 (\$45.00/Count)

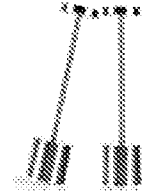

SUNLISTGO Cordless Table Lamp 13.4 inch, LED Touch Lamp Rechargeable Desk Lamp
★★★★☆ 184
\$55.99

Tools & Home Improvement > Lighting & Ceiling Fans > Lamps & Shades > Desk Lamps

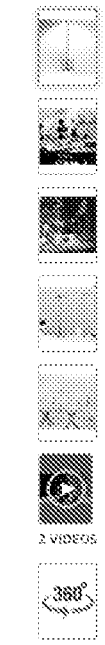

JALVDE Cordless Rechargeable LED Table Lamp, 13.5 inches Modern Portable Desk Lamps 3 Levels Brightness, 6000 mAh Battery Powered Table Light for Bar Restaurant Dining Table Lamp

Visit the JALVDE Store
★★★★☆ ~ 988 ratings
| 36 answered questions

\$47.99

FREE Returns
Get \$50 off instantly; Pay \$0.00 \$47.99 upon approval for the Amazon Rewards Visa Card. No annual fee.

Color: **Gold - Tall**

 \$47.99	 \$89.99	 \$47.99
 \$49.99	 \$47.99	 \$47.99

Style Minimalist
Brand JALVDE
Color Gold - Tall

Delivery **Pickup**

\$47.99
FREE Returns
FREE delivery **Tuesday, January 17**
Or fastest delivery **Friday, January 13**. Order within 12 hrs 52 mins
 Select delivery location

In Stock.

Qty: 1

Secure transaction

Ships from **Amazon**
Sold by **JALVDE**

Return policy: Eligible for Return, Refund or Replacement within 30 days of receipt.
Support: Free Amazon tech support included.

prime

Enjoy fast, FREE delivery, exclusive deals and award-winning movies & TV shows with Prime
Try Prime and start saving today with **Fast, FREE Delivery**

Add a gift receipt for easy returns



Color: Gold

Rechargeable Wireless Table Lamp

Whether it's for reading, dinner or a party, it is suitable. Whether it is a living room, dining room or restaurant, it fits with your décor. It directs ambient light downwards, Your room feels clutter-free and roomy



Modern & Minimalist Style

Battery Operated Table Lamps

- 13.5 inches in this pic

We do believe less is more. We always implement this design philosophy and incorporate them into every one of our products. Simple shape, with exquisite all-aluminum material, placed in a variety of scenes are complementary. Form and function in one.



Color	Gold - Tall
Product Dimensions	3.15"D x 3.15"W x 13.5"H
Special Feature	6000 mAh large-capacity battery, Minimalist design, 360-degree light, Flicker free, eye protection, Long service life, all-metal body, Cordless, portable
Light Source Type	LED
Material	Aluminum
Lamp Type	LED
Room Type	Office
Shade Color	Gold
Shade Material	Metal
Power Source	Battery Powered
Shape	Round
Switch Style	Push Button
Number of Light Sources	20
Theme	Minimalist
Connectivity Technology	USB
Included Components	Light kit included
Wattage	4 watts
Manufacturer	JALVDE
Part Number	Maryan
Item Weight	1 pounds
Item model number	LMP-JAL-001
Batteries	1 Lithium ion batteries required. (included)
Assembled Height	13.5 inches
Assembled Length	3.15 inches
Assembled Width	3.15 inches
Voltage	5 Volts (DC)
Special Features	6000 mAh large-capacity battery, Minimalist design, 360-degree light, Flicker free, eye protection, Long service life, all-metal body, Cordless, portable
Light Direction	Downlight
Batteries included?	Yes
Batteries Required?	Yes
Luminous Flux	150 Lumen
Color Temperature	3000 Kelvin

	4.4 out of 5 stars
Best Sellers Rank	#19,142 in Tools & Home Improvement (See Top 100 in Tools & Home Improvement) #152 in Desk Lamps
Date First Available	October 16, 2020

Warranty & Support

Product Warranty: For warranty information about this product, please [click here](#)

Feedback

Would you like to tell us about a lower price?



What can we help you find?

Orders & Sign In

0



Willy White Plaster Pedestal Side Table

[43 Reviews](#)

SKU: 400832

\$349.00

Ship It

Purchase now and we'll ship when it's available.
Estimated in mid February.

ZIP Code: [60540](#)

//////////

FREE CURBSIDE PICKUP AT STORE

[Select Store](#)

Learn how to earn \$35 back in Reward Dollars* or now through February 26: Up to 24 Months Special Financing on qualifying purchases***

Details

Reviews

4.8

Average rating based on **43 Reviews**

Reviews are verified for authenticity.



1 Year Ago

Helpful?

Yes

7

No

0

REPORT

Originally posted on Willy White Plaster Round Pedestal Side Table by Leanne Ford

WILLY SIDE TABLE=SASS AND CLASS!!!

I ordered this table afraid it would look silly with my traditional stuff. On the contrary: The Willy White Plaster side table gave my entire room a kick in its create butt! When friends walk in, they zero in on the table and comment how it elevates the room to stylish and FUN!

Show More

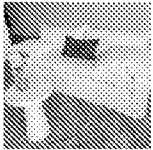

CLEO 1 Year Ago

Helpful?

Yes

7

No

0

REPORT

Originally posted on Willy White Plaster Round Pedestal Side Table by Leanne Ford

Love this table!



Hall172 Years ago

Helpful?

Yes:

17

No:

2

REPORT

Originally posted on Willy White Plaster Round Pedestal Side Table by Leanne Ford

[VIEW ALL](#)

Dimensions

Assembly & Installation

<i>Search Notes</i> 	Application/Control No. 35/513,766	Applicant(s)/Patent Under Reexamination RIO, SAMY
	Examiner SARAH L SMITH	Art Unit 2919

CPC - Searched*		
Symbol	Date	Examiner
F21S9/022	01/10/2023	/SLS/
F21S10/023	01/10/2023	/SLS/
F21S10/005	01/10/2023	/SLS/
F21S13/00	01/10/2023	/SLS/
F21L4/00	01/10/2023	/SLS/
F21L2001/00	01/10/2023	/SLS/
F21L4/02,04,005,022,045,085	01/10/2023	/SLS/
F21L21/00	01/10/2023	/SLS/
F21L14/02,023	01/10/2023	/SLS/

CPC Combination Sets - Searched*		
Symbol	Date	Examiner

US Classification - Searched*			
Class	Subclass	Date	Examiner
D26	37-44,46-52,60-61,67,72	01/06/2023	/SLS/
D10	111,114.1,114.9	01/06/2023	/SLS/

* See search history printout included with this form or the SEARCH NOTES box below to determine the scope of the search.

/S.L.S./ Examiner, Art Unit 2919	/CHRISTY NEMETH/ Primary Examiner, Art Unit 2922
-------------------------------------	---

Search Notes 	Application/Control No. 35/513,766	Applicant(s)/Patent Under Reexamination RIO, SAMY
	Examiner SARAH L SMITH	Art Unit 2919

Search Notes		
Search Notes	Date	Examiner
DAV inventor search - RIO, SAMY	01/06/2023	/SLS/
PE2E inventor & assignee search - RIO, SAMY and PETIT FRITURE	01/06/2023	/SLS/
PE2E title search - camp light, safety light, garage light, security light, emergency light, foldable light, extendable light, portable lamp, handheld light	01/06/2023	/SLS/
Orbit inventor & assignee search - RIO, SAMY and	01/06/2023	/SLS/
Orbit title search - camp, portable, handheld, work, extendable, flashlight in Locarno 26-02; camp, portable, handheld, extend in Locarno 26-05	01/10/2023	/SLS/
Google search - inventor, assignee, portable lamp, floating lamp, fishing light, camp light	01/11/2023	/SLS/
Amazon search - portable lamp	01/11/2023	/SLS/
Facebook and Instagram search - assignee and inventor	01/11/2023	/SLS/

Interference Search			
US Class/CPC Symbol	US Subclass/CPC Group	Date	Examiner

/S.L.S./ Examiner, Art Unit 2919	/CHRISTY NEMETH/ Primary Examiner, Art Unit 2922
-------------------------------------	---

PE2E SEARCH - Search History (Prior Art)

Ref #	Hits	Search Query	DBs	Default Operator	Plurals	British Equivalents	Time Stamp
L2	0	((("PETITE") near3 ("FRITURE"))).AS,AAN M.	(US-PGPUB; USPAT; FPRS; JPO; DERWENT)	OR	ON	ON	2023/01/06 10:25 AM
L4	0	((("RIO") near3 ("SAMMY"))).INV.	(US-PGPUB; USPAT; FPRS; JPO; DERWENT)	OR	ON	ON	2023/01/06 10:26 AM
L19	6178	(D26/37-44,46-52).ccls.	(US-PGPUB; USPAT; FPRS; JPO; DERWENT)	OR	ON	ON	2023/01/06 10:44 AM
L20	1024	(D26/72,61).ccls.	(US-PGPUB; USPAT; FPRS; JPO; DERWENT)	OR	ON	ON	2023/01/06 10:44 AM
L21	1109	(D10/111,114.1,114.9).ccls.	(US-PGPUB; USPAT; FPRS; JPO; DERWENT)	OR	ON	ON	2023/01/06 10:45 AM
L24	7281	(F21L2001/00 OR F21L4/02,04,005,022,045,085 OR F21L21/00 OR F21L14/02,023).cpc. NOT (process OR assembly OR system OR method)	(US-PGPUB; USPAT; FPRS; JPO; DERWENT)	OR	ON	ON	2023/01/06 10:46 AM
L27	3580	(Camp ADJ light OR camp ADJ lamp OR light ADJ saber OR portable ADJ lamp OR portable ADJ light OR handheld ADJ light OR video ADJ light OR photography ADJ light).ti. NOT (process OR assembly OR system OR method)	(US-PGPUB; USPAT; FPRS; JPO; DERWENT)	OR	ON	ON	2023/01/06 10:49 AM
L48	602	(safe near3 light OR safe near3 lamp OR security near3 light OR security near3 lamp OR emergency ADJ light OR fold near3 light OR extend near3 light OR traffic near3 light).ti. NOT (process OR assembly OR system OR method)	(US-PGPUB; USPAT; JPO)	OR	ON	ON	2023/01/10 01:25 PM
L51	670	D26/60.ccls.	(US-PGPUB; USPAT; FPRS; JPO; DERWENT)	OR	ON	ON	2023/01/10 01:52 PM
L58	2424	(F21L4/00).cpc. NOT (process OR assembly	(US-PGPUB; USPAT; JPO; DERWENT)	OR	ON	ON	2023/01/10 03:21 PM

L62	1373	OR system OR method) (F21S9/022 OR F21S10/023 OR F21S10/005 OR F21S13/00).cpc. NOT (process OR assembly OR system OR method)	(US-PGPUB; USPAT; JPO; DERWENT)	OR	ON	ON	2023/01/10 03:30 PM
L63	1232	D26/67.ccls.	(US-PGPUB; USPAT; JPO; DERWENT)	OR	ON	ON	2023/01/11 07:26 AM

PE2E SEARCH - Search History (Interference)

There are no Interference searches to show.